

03

STORA-DRAIN

SELF A15 / B125



NEW MODEL

POLYESTER CONCRETE DRAINAGE CHANNELS

The polyester concrete drainage channels from the **STORA SELF** range are the ideal solution for surface water drainage around private houses, garage doors, terraces and domestic driveways, due to their low and high strength. The channels are available in several widths and in 1m or 0,5m lengths. All channels are level invert and are connected by means of a tongue and groove jointing system. A wide range of onlay gratings is available with the system to suit a variety of applications.

Channel **STORA SELF** with (DIC) ductile iron cast grating

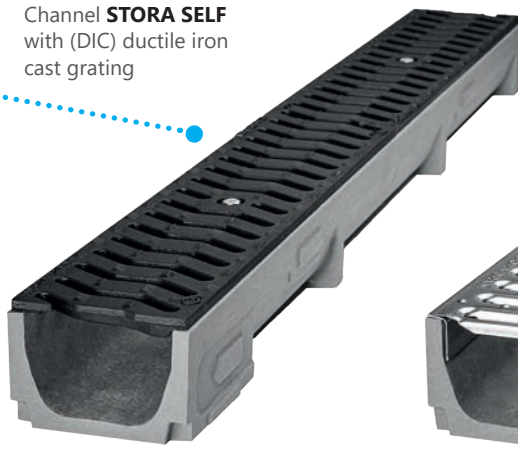

Channel **STORA SELF** with galvanized grating

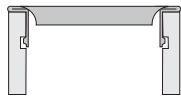
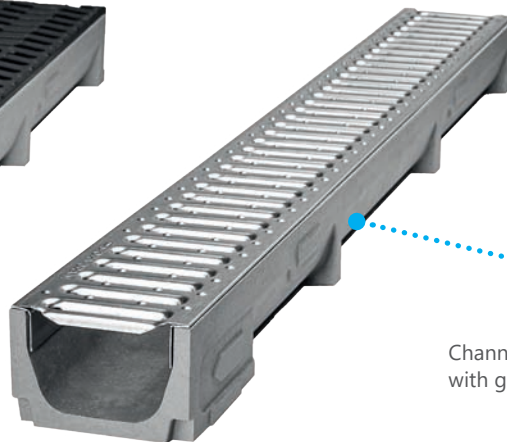

Anchorage FIX system

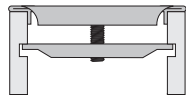

Anchorage bridge + screw with galvanized grating

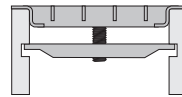

Anchorage bridge + screw with mesh grating

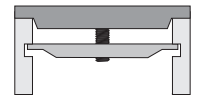

Anchorage bridge + screw with iron grating



SELF 100 H=60

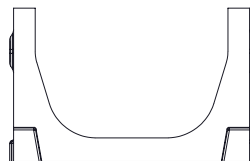

SELF 100 H=80

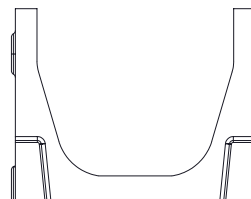

SELF 100 H=100

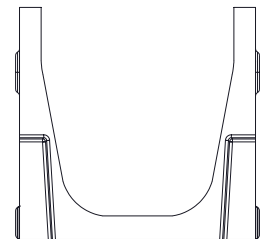

SELF 100 H=120

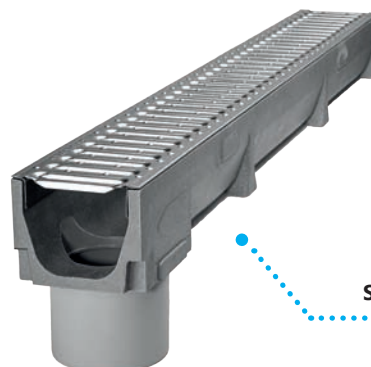

STORA SELF with pipe

STORA-DRAIN
* **SELF 100**
CHANNEL + GRATING

A15



- FIX system
- galvanized grating slot 10mm

A15



- FIX system
- galvanized grating slot 6mm

B125



- anchorage screw
- galvanized mesh grating

B=100 D=120	H	Vertical outlet	Article number	Retail price Eur/pcs.	Article number	Retail price Eur/pcs.	Article number	Retail price Eur/pcs.
channel 1,0m	60	Ø 110	SE10061100N	19,00	SE10061102N	20,00	SE10061204N	82,50
channel 1,0m	80	Ø 110	SE10081100N	20,00	SE10081102N	21,00	SE10081204N	85,00
channel 1,0m with pipe Ø 110	80	Ø 110	SE10081100PN	28,00	SE10081102PN	29,00	SE10081204PN	93,00
channel 1,0m	100	Ø 110	SE10101100SN	23,50	SE10101102SN	24,50	SE10101204SN	87,50
channel 0,5m standard	100	Ø 110	SE10105101N	16,50	SE10105103N	17,00	SE10105205N	61,50
channel 1,0m with pipe Ø 110	100	Ø 110	SE10101100PN	31,50	SE10101102PN	32,50	SE10101204PN	95,50
channel 1,0m	120	Ø 110	SE10121100N	27,00	SE10121102N	28,00	SE10121204N	90,00

STORA-DRAIN
* **SELF 100**
CHANNEL + GRATING

B125

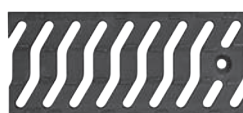

- anchorage screw
- ductile iron grating "S"

B125



- anchorage screw
- ductile iron grating 10x30

B125

CTL coating



- anchorage screw
- ductile iron grating 10x30

B=100 D=120	H	Vertical outlet	Article number	Retail price Eur/pcs.	Article number	Retail price Eur/pcs.	Article number	Retail price Eur/pcs.
channel 1,0m	60	Ø 110	SE10061367	44,00	SE10061334N	44,00	SE10061335N	50,50
channel 1,0m	80	Ø 110	SE10081367	46,50	SE10081334N	46,50	SE10081335N	53,00
channel 1,0m with pipe Ø 110	80	Ø 110	SE10081367P	54,50	SE10081334PN	54,50	SE10081335PN	61,00
channel 1,0m	100	Ø 110	SE10101367S	49,00	SE10101334SN	49,00	SE10101335SN	55,50
channel 0,5m standard	100	Ø 110	SE10105367	34,00	SE10105334N	34,00	SE10105335N	37,50
channel 1,0m with pipe Ø 110	100	Ø 110	SE10101367P	57,00	SE10101334PN	57,00	SE10101335PN	63,50
channel 1,0m	120	Ø 110	SE10121367	52,50	SE10121334N	52,50	SE10121335N	59,00

* half of quantity on one pallet are with possibility to make vertical outlet

SELF

i All dimensions **B, D, L, H** are in mm.

STORA-DRAIN

SELF

150

CHANNEL + GRATING

A15

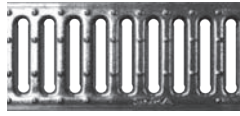

- anchorage screw
- galvanized grating slot 10mm

B125

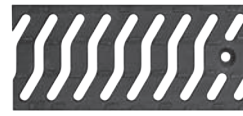

- anchorage screw
- ductile iron grating "S"

B125

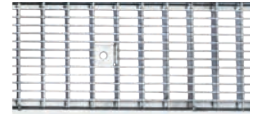

- anchorage screw
- galvanized mesh grating

B=150 D=195	H	Vertical outlet	Article number	Retail price Eur/pcs.	Article number	Retail price Eur/pcs.	Article number	Retail price Eur/pcs.
channel 1,0m	120	Ø 160	SE15121110	70,00	SE15121327	95,00	SE15121206	145,00
channel 1,0m	195	Ø 160	SE15191110	75,00	SE15191327	107,50	SE15191206	150,00
channel 0,5m cross	195	390 x 125	SE15195111	52,50	SE15195327	75,00	SE15195207	105,00

STORA-DRAIN

SELF

200

CHANNEL + GRATING

B125

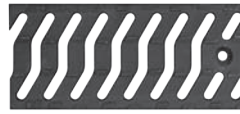

- anchorage screw
- ductile iron grating "S"

B=200 D=245	H	Vertical outlet	Article number	Retail price Eur/pcs.
channel 1,0m	130	Ø 200	SE20131326	120,00
channel 1,0m	240	Ø 200	SE20241326	135,00
channel 0,5m cross	240	390 x 125	SE20245326	94,50

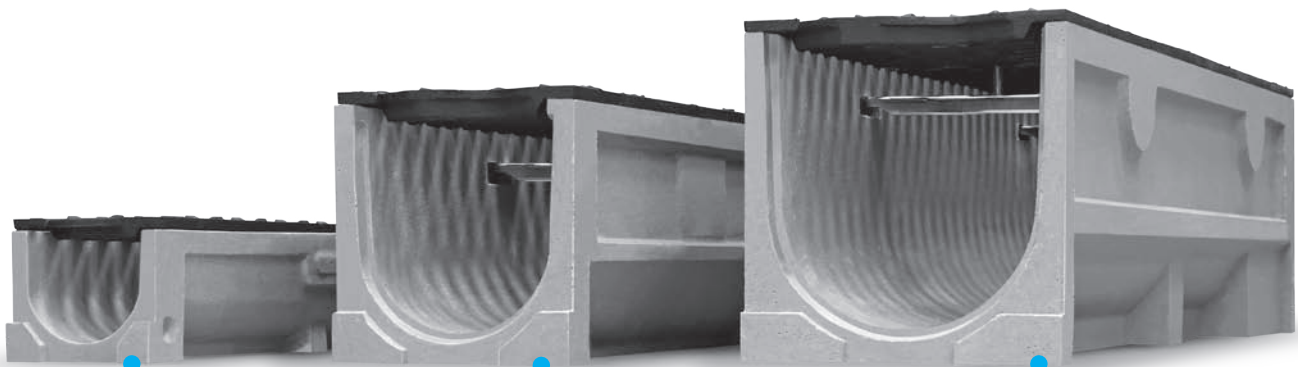

SELF 100

SELF 150

SELF 200

SUMP UNIT 100

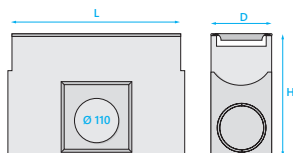

A15



- One part sump unit + bucket + galvanized grating slot 10mm

A15



- One part sump unit + bucket + galvanized grating slot 6mm

B125



- One part sump unit + bucket + galvanized mesh grating

L	500	500	500
H	250	250	250
Outlet front/side	Ø 110	Ø 110	Ø 110
Article number	AU10011101N for H=60-120	AU10011103N for H=60-120	AU10011205N for H=60-120
Retail price Eur/pcs.	87,50	88,00	128,50

SUMP UNIT 100

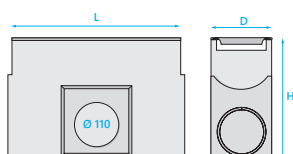

B125

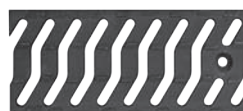

- One part sump unit + bucket + iron grating slot "S"

B125



- One part sump unit + bucket + iron grating mesh 10x30

B125

KTL coating



- One part sump unit + bucket + iron grating mesh 10x30 KTL

L	500	500	500
H	250	250	250
Outlet front/side	Ø 110	Ø 110	Ø 110
Article number	AU10011367 for H=60-120	AU10011334N for H=60-120	AU10011335N for H=60-120
Retail price Eur/pcs.	97,00	97,00	100,50

SUMP UNIT 150*

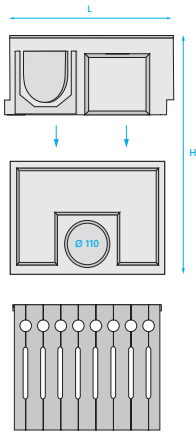

A15

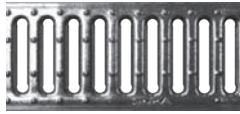

■ Two parts sump unit + bucket + galvanized grating slot 10mm

B125

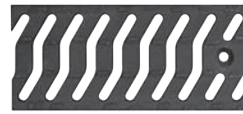

■ Two parts sump unit + bucket + iron grating slot "S"

B125



■ Two parts sump unit + bucket + galvanized mesh grating

L	500	500	500
H	545	545	545
Outlet front/side	Ø 110/160/200	Ø 110/160/200	Ø 110/160/200
Article number	AU10401111	AU10401327	AU10401207
Retail price Eur/ pcs.	161,00	184,00	217,50

SUMP UNIT 200*

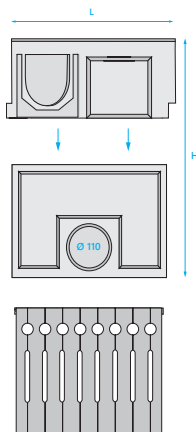

B125

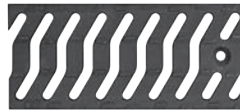

■ Two parts sump unit + bucket + iron grating slot "S"

L	500
H	590
Front/side outlets	Ø 110/160/200
Article number	AU10401326
Retail price Eur/ pcs.	214,00

STEPPED FALL 100/150/200

Type	For channel (H)	Article number	Retail price Eur/ pcs.
100	H 60/80100/120	AL10000101	10,00
150	H 120/195	AL15000101	12,50
200	H 130/240	AL20000101	15,00

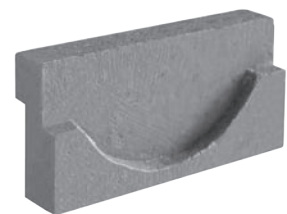

* For channels **SELF 150 / H=120** or **SELF 200 / H=130**, is necessary to buy STEPPED FALL to connect channels with SUMP UNIT.

ENDCAPS 100/150/200

Type	H	Outlet	Article number	Retail price Eur/pcs.
100	60	–	AE10062000N	4,00
100	60	Ø 50	AE10262000N	7,50
100	80	–	AE10012000N	4,00
100	80	Ø 110	AE10172000N	7,50
100	100	–	AE10102000N	4,00
100	100	Ø 110	AE10112000N	7,50
100	120	–	AE10022000N	4,50
100	120	Ø 110	AE10032000N	7,50
150	120	–	AE15022000	12,00
150	195	–	AE15002000	12,00
150	195	Ø 110	AE15012000	17,50
200	130	–	AE20022000	12,00
200	240	–	AE20002000	12,00
200	240	Ø 160	AE20012000	17,50

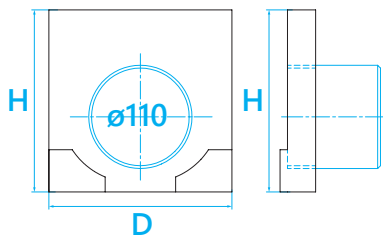
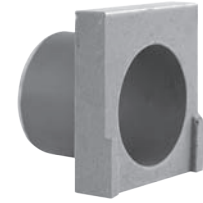

Endcap with pipe

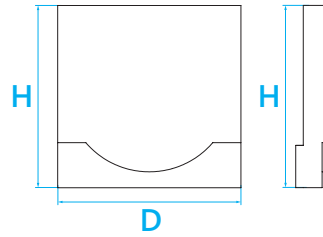

Closed endcap

SIPHON 100

Type	For outlet	Article number	Retail price Eur/pcs.
Two parts siphon - installation only on channel B=100 with pipe	Ø 110	AS10400000	15,00



SEALANT

Type	Color	Capacity	Article number	Retail price Eur/pcs.
Sealant to connect elements from polyester concrete	grey	310 ml	PUP0000310	15,00

